



KAYAK CANOE

Eco friendly paddle boats



WORLDWIDE ROTOMOULDER

since 1949



Roto Group is an international company specialized in the production of plastic products. The roots of the family-run business go back to 1949. The headquarters is in the Slovenia. Production is organized in 8 factories in European countries and 1 in Africa. The company employs more than 600 people and had revenues of 110 mio euro. ROTO exports its products to 65 countries all around the world. Run by the Pavlinjek family, the company has established a reputation as a reliable business partner.

ROTO manufactures more than 4,400 different products using rotational molding technology. Indeed, ROTO is one of the market leaders in its industry. It has been responsible for many innovations in plastic- molding technology. The R&D department has made numerous innovations in product design, materials and production technologies.

The company's main production segments are final products for sport, nautic, agriculture, ecology, gardening. Using plastics composites and the latest production technologies, ROTO also makes kayaks, canoes and high-performance boats.

Manufacturing as a custom molder, ROTO serves a wide variety of industry sectors including construction, automotive, nautical, logistics, aquaculture and agricultural machinery. Its custom-molded products include fuel and water tanks for motorcycles, tractors, trucks, sailing boats and motorboats, caravans and motorhomes, and components for many different machines.

ROTO works to increase its products' value by enhancing their design, intelligently using materials and modern production technologies, and ensuring a high-quality nish. The company also takes great pride in its after-sales service and customer technical support.

eco friendly paddle boats

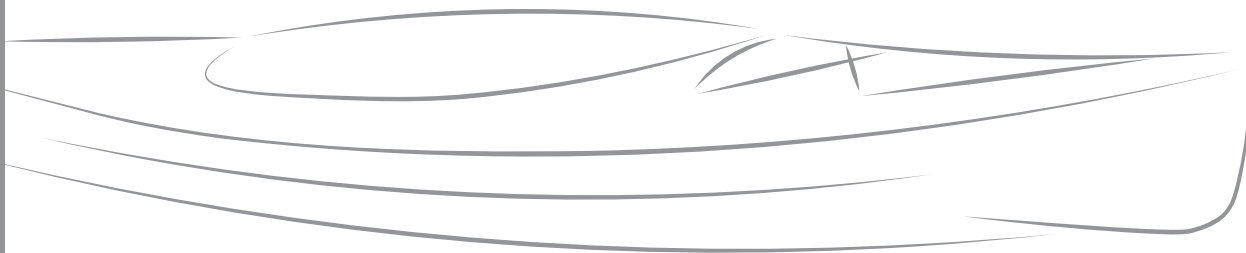

FROM IDEA TO THE PRODUCT



3D scanning, product design, material development



Largest 3D printer on the world

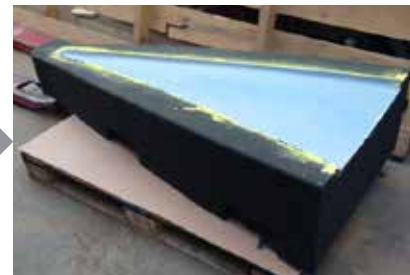

Form for AI casting

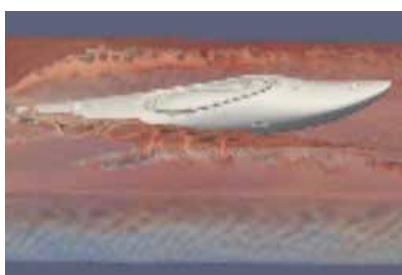

Prototyping



Hydrodynamic and bouyancy test



Hull finishing



59 rotational moulding machines and robots



Assembling



Distribution

EXPERIENCE THE ADVANTAGES



Product is 100% recyclable after use



Light weight



UV resistant



Resistant to high and low temperatures (-65°C, +85°C)



High quality and durable material "unbreakable" PE



Free choice of equipment, accessories and colour



customize - your personal design



Fahrtauglichkeitsbescheinigungen certifikat





save the nature
recycle your old kayak/canoe



Benjamin Savšek - Roto ambassador of PeCycled kayaks and canoes

Return your old kayaks and canoes to Roto

We can recycle them and produce new products. You will save the nature and receive discount by buying new rotoAttivo kayaks and canoes.

100%
PE RECYCLED





RECYCLING AND SUSTAINABILITY

The Roto Group has been recycling polyethylene for over 30 years. We buy waste polyethylene on the market and recycle our used products that we get from customers 100%. In the past, we used these materials again to make garden furniture and planters.

This year we started producing a special **PE cycled line** of kayaks and canoes. In our laboratory, we produce material from recycled packaging, which is collected from the nature during ecological campaigns. Waste packaging is supplied to us also by shops and other factories.

We care for the future generations. We do everything we can to protect a clean environment.



Canadier 525

Viking 450

Dalmatic 270

Todo 260

Buran 430

Buran 488

Buran 520

KAYAK CANOE



CANOE

RotoAttivo canoes are high-quality, durable polyethylene kayaks designed for recreational paddling, fishing, and adventurous excursions.

Robust and lightweight, they resist impacts, making them ideal for rivers, lakes, and even coastal waters. Featuring ergonomic designs for comfort, spacious interiors, and excellent stability, RotoAttivo canoes cater to both beginners and experienced paddlers.



CANADIER 525

The Canadier 525 is a classic open canoe crafted from durable 3-layer polyethylene. It offers versatility with options for both plastic and wooden seats.

The plastic seats feature built-in storage compartments, enhancing practicality. Lightweight and equipped with integrated handles, this canoe is easily transported.

Stable and spacious, the Canadier 525 is ideal for recreational paddling, exploration, or rental services. Moreover, it can be sustainably produced using PeCycled, our recycled material.

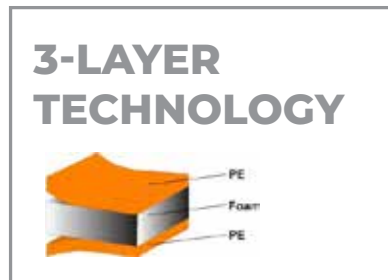

PE SEATS



WOODEN SEATS

LENGTH / WIDTH	525 cm / 93 cm
HEIGHT	57 cm
WEIGHT	49 kg
CAPACITY, MAX.	320 kg
CONSTRUCTION	3-layer HDPE

COLORS





4 W



4 P



5 W



5 PW



CODE	2300591830	2300095540	23000691830	2300095690
SEAT	4 wood seats	4 PE seats	5 wood seats	3 PE seats, 2 wood seats

CANADIER 455

The Canadier 455 is a timeless canoe, ideal for recreational paddling on lakes, rivers, and even calm coastal waters.

Manufactured from robust 3-layer polyethylene, this canoe offers exceptional stability and versatility for a wide range of users. The inner layer provides structural rigidity and inherent unsinkability, while the outer layers protect the core from impacts. Experience the joy of effortless paddling with the Canadier 455.

3-LAYER TECHNOLOGY



PE SEATS



WOODEN SEATS

LENGTH / WIDTH	455 cm / 90 cm
HEIGHT	48 cm
WEIGHT	43 kg
CAPACITY, MAX.	250 kg
CONSTRUCTION	3-layer HDPE

COLORS





2 W



2 P



3 W



3 P



CODE	2300091830	2300791830	2300391830	2300491830
SEAT	2 wood seats, 1 yoke	2 PE seats, 1 yoke	3 wood seats	3 PE seats

VIKING 450

The VIKING is a compact and balanced canoe manufactured from durable 1 or 3-layer polyethylene for enhanced buoyancy. Ideal for canoe centers and rental businesses, it offers excellent stability and manoeuvrability. Comfortable webbing or PE seats ensure a pleasant paddling experience, while ample space accommodates passengers and gear. The VIKING is perfect for group outings and family adventures.



PE SEATS



WOODEN SEATS



PE BACKREST
folding backrest for easier
long distance paddling

LENGTH / WIDTH	450 cm / 90 cm
HEIGHT	48 cm
WEIGHT	40 - 43 kg
CAPACITY, MAX.	250 kg
CONSTRUCTION	1-layer HDPE and 3-layer HDPE

COLORS



red



dark green



recycled



1-LAYER



3 W



3 P



3 PB

CODE	2300091800	2300091807	2300091808
SEAT	3 wood seats	3 PE seats	3 PE seats with backrest

3-LAYER



3 W



3 P



3 PB

CODE	2300091540	2300091547	2300091548
SEAT	3 wood seats	3 PE seats	3 PE seats with backrest

TRAPPER 450

The Trapper seamlessly combines the stability of a canoe with the ease of entry and exit of a sit-on-top kayak. Ideal for rentals or fun family outings, the Trapper comfortably accommodates two adults and a child. Experience the versatility and enjoyment of this unique design.



LENGTH / WIDTH	450 cm / 90 cm
HEIGHT	48 cm
WEIGHT	48 kg
CAPACITY, MAX.	160 kg
CONSTRUCTION	1-layer HDPE
CODE	2300091550

COLORS



YUMA 430

The Yuma canoe is a real “work horse” that is extremely durable and suits well for rentals & family outings. It has a great carrying capacity to take all your camping gear on board. Three rotomolded seats are made from recycled plastic and are easy to care for. The seats are comfortable & add extra buoyancy. Yuma is a super stable & durable canoe that can even be used on the rocky rivers.

 Yuma **seats** are made from recycled plastic



LENGHT / WIDTH	470 cm / 95 cm
WEIGHT	48 kg
CAPACITY, MAX.	300 kg
COCKPIT DEPTH	36 cm
CONSTRUCTION	1-layer HDPE
FEATURES	3 PE seats, 2 rope handles
CODE	2300091100
COLORS	<div style="display: flex; gap: 10px;"> <div style="background-color: red; width: 20px; height: 10px; display: inline-block;"></div> red <div style="background-color: green; width: 20px; height: 10px; display: inline-block;"></div> green </div>





SEA KAYAK

Rotoattivo sea kayaks are designed and built for ocean and coastal exploration. Made from durable rotomolded polyethylene, these kayaks are lightweight, comfortable and functional. Ideal for both novice and seasoned kayakers, Rotoattivo sea kayaks combine stability and efficiency, making them a reliable choice for long-distance paddling and open-water adventures.

BURAN 430

Buran 430 a modern sea kayak with a shorter haul for added maneuverability. Despite its short length, Buran 430 has ample foot room and two dry storage compartments.

It can also be equipped with an on-demand rudder, which makes it even more agile and perfect for some close to shore or lake exploration.

LENGTH / WIDTH 430 cm / 60 cm

HEIGHT 40 cm

WEIGHT 23 kg

CAPACITY, MAX. 90 kg

COCKPIT 90 x 47 cm

BASIC
[code: 2300073710] drain plug, adjustable seat, deckfitting with handles, comfortable seat

WEEKEND
[code: 2300373710] drain plug, adjustable seat, adjustable backrest, oval hatch, bulkhead, deckfitting with handles, cushioned seats, round hatch, rubbernet for luggage, footrest, comfortable seat

EXPEDITION
[code: 2300573710] drain plug, adjustable seat, adjustable backrest, oval hatch, bulkhead, deckfitting with handles, cushioned seats, round hatch, rubbernet for luggage, steering footrest, navigator rudder system, comfortable seat

COLORS



BURAN 488

Buran 488 the kayak for tall and / or heavy paddlers - or persons with limited mobility. XL - cockpit for easy entry and exit. High volume - extreme load capacity, plenty of space in the kayak especially in the leg and foot area. Enough space even for shoe size 47 and up. Very stable and fast - like the shorter version. In the rear area a newly developed featur - a multifunctional insert - easily upgradeable for a rudder. Useable for a drainplug or a rudder sleeve.

LENGHT / WIDTH 488 cm / 63 cm

HEIGHT 41 cm

WEIGHT 26 - 29 kg

CAPACITY, MAX. 130 kg

COCKPIT 95 x 50 cm

BASIC
[code: 2300074740] drain plug, adjustable seat, deckfitting with handles, comfortable seat

WEEKEND
[code: 2300374740] drain plug, adjustable seat, adjustable backrest, oval hatch, bulkhead, deckfitting with handles, cushioned seats, round hatch, rubbernet for luggage, footrest, comfortable seat

EXPEDITION
[code: 2300574740] drain plug, adjustable seat, adjustable backrest, oval hatch, bulkhead, deckfitting with handles, cushioned seats, round hatch, rubbernet for luggage, steering footrest, navigator rudder system, comfortable seat

COLORS



BURAN 520

Buran 520 is a pure breed Sea Kayak-long and narrow, perfect for covering long distances with speed.

It has plenty of storage areas for long trips and a rudder for quick turning. It comes in two different trim levels weekend and expedition.

LENGTH / WIDTH	520 cm / 60 cm
HEIGHT	40 cm
WEIGHT	33 kg
CAPACITY, MAX.	120 kg
COCKPIT	78 x 39 cm
WEEKEND [code: 2300473720]	handles, drain plug, rubbernet for luggage, footrest, comfortable seat, cushion soft seats, deckfitting with rubberstrap, side handles, deckfitting
EXPEDITION [code: 2300473730]	handles, drain plug, rubbernet for luggage, footrest, steering footrest, navigator rudder system, comfortable seat, cushion soft seats, deckfitting with rubberstrap, side handles, deckfitting,

COLORS



AKULA 488

Unsinkable even when full, due to partitioned storage space in bow and stern. The Akula, the shark, splits the water with its sharply cut bow like a shark's dorsal fin. Delsyk Design Akula, is a thoroughbred sea kayak by the world-renowned designer Mike Neckar, in the 16 foot class, a kayak that inspires.

The Delsyk Design Akula will impress even long-time experts on the stage, speed, stability and maneuverability paired with an accomplished paddler or ambitious paddler. The Akula will take you to places that can only be reached by kayak.

LENGTH / WIDTH 488 cm / 58 cm

WEIGHT 28 kg

CAPACITY, MAX. 150 kg

COCKPIT 84 x 38 cm

STORAGE SPACE BOW 75 l

STORAGE SPACE STERN 88 l

CARGO HATCH BOW 34.5 x 23.5 cm

CARGO HATCH STERN 38 x 35.5 cm

WITH RUDDER
[code: 2300522200] ergonomic comfort padded soft seat with adjustable leg angle, height and angle adjustable padded backrest, adjustable steering footrest, rudder, all-round lifeline, loose mooring and towing line, deck net, front and rear waterproof storage space with neopren and PE cover

COLORS



NIFTY 385

Nifty stands for a kayak family from 3.85 to 4.4 meters and is therefore ideally adaptable to your needs and areas. The slim multi-bend frame shape with pronounced keel jump, makes the Delsyk Nifty 385 very fast and safe at the same time. The steering and foot pedals can be adjusted perfectly to the paddler while sitting in the boat. River, lakes or longer tours along the protected coast, the Delsyk Nifty 385 masters every situation.

LENGHT / WIDTH	385 cm / 65 cm
WEIGHT	23 kg
CAPACITY, MAX.	160 kg
COCKPIT	86 x 41 cm
STORAGE SPACE FORWARD	40 L
STORAGE SPACE STERN	78 L
STORAGE HATCH FORWARD	20.3 cm
STORAGE HATCH STERN	35.6 x 30.5 cm
BASIC [code: 2300522160]	ergonomic comfort padded soft seat with adjustable leg angle, height and angle adjustable padded backrest, footrest, all-round lifeline, loose mooring and towing line, deck net, rear waterproof storage space with neopren and PE cover, front waterproof storage space with round hatch
WITH RUDDER [code: 2300522170]	ergonomic comfort padded soft seat with adjustable leg angle, height and angle adjustable padded backrest, adjustable steering footrest, rudder, all-round lifeline, loose mooring and towing line, deck net, rear waterproof storage space with neopren and PE cover, front waterproof storage space with round hatch

COLORS



NIFTY 430

The Nifty 430 is the kayak with the best surf and playboat characteristics of the Nifty family. The slim multi-bend frame shape with pronounced keel jump, makes the Delsyk Nifty 430 very fast and safe at the same time. The ergonomics, in seat and backrest inclination and backrest height adjustable and comfortable seat, two watertight storage compartments and numerous mounting options on deck, make the Delsyk Nifty 430 the ideal companion for your individual adventure, from the small everyday escape after work, to the extended kayak expedition.

LENGTH / WIDTH 430 cm / 63 cm

WEIGHT 26 kg

CAPACITY, MAX. 140 kg

COCKPIT 86 x 41 cm

STOWAGE SPACE FRONT 40 L

STOWAGE SPACE STERN 78 L

STOWAGE SPACE OPENING FRONT 30.5 x 16.5 cm

STOWAGE SPACE OPENING STERN 40.6 x 30.5 cm

WITH RUDDER
[code: 2300522180]

ergonomic comfort padded soft seat with adjustable leg angle, height and angle adjustable padded backrest, adjustable steering footrest, rudder, all-round lifeline, loose mooring and towing line, deck net, front and rear waterproof storage space with neopren and PE cover

COLORS



NIFTY 440

The Nifty 440 is the tourer for big, heavy paddlers, or those who like to have more space in the kayak. The Nifty 440 is fully equipped and offers legroom for paddlers up to 2 meters. The Delsyk Nifty 440, is made of extremely durable and long-lasting polyethylene and ensures years of paddling pleasure even in rough conditions on rivers and lakes. Circumferential lifelines, deck rubber cords and deck nets, complete the all-around perfect features of the Delsyk Nifty 440.

LENGTH / WIDTH 440 cm / 62 cm

WEIGHT 27 kg

CAPACITY, MAX. 160 kg

COCKPIT 95 x 45 cm

STORAGE IN FRONT 45 L

STORAGE IN STERN 82 L

STORAGE OPENING IN FRONT 25 cm

STORAGE OPENING IN STERN 40 x 26 cm

WITH RUDDER

[code: 2300522190]

ergonomic comfort padded soft seat with adjustable leg angle, height and angle adjustable padded backrest, adjustable steering footrest, rudder, all-round lifeline, loose mooring and towing line, deck net, front waterproof storage space with round hatch, rear waterproof storage space with oval hatch

COLORS



CALYPSO 460

CALYPSO is an easy going tandem kayak offering excellent primary and secondary stability plus many comfy standard features. The seats come with collapsable backrest. Plenty of room for long legs, lots of gear and a big cockpit to facilitate entry and exit.

LENGHT / WIDTH	460 cm / 80 cm
HEIGHT	40 cm
WEIGHT	36 kg
CAPACITY, MAX.	240 kg
COCKPIT	214 x 55 cm
BASIC [code: 2300091790]	handles, drain plug, rubbernet for luggage, footrest, seat with collapsable backrest
WEEKEND [code: 2300391790]	handles, drain plug, bulkhead, round hatch, rubbernet for luggage, footrest, seat with collapsable backrest
EXPEDITION [code: 2300491790]	handles, drain plug, bulkhead, round hatch, rubbernet for luggage, footrest, seat with collapsable backrest, steering footrest, navigator rudder system

COLORS



SALISH 450

Delsyk Salish is a compact two-person kayak. Fully equipped, it has adjustable seats, a child seat and rudder with steering pedals. Made in Europe, for your everyday adventures and the relaxed experience of the recreational world of water. The Salish is suitable for paddling beginners due to its high initial stability and extremely stable length/width ratio.

LENGTH / WIDTH	450 cm / 76 cm
WEIGHT	34 kg
CAPACITY, MAX.	315 kg
COCKPIT	108 x 43 cm
STORAGE SPACE STERN	72 L
BASIC [code: 2300522210]	ergonomic comfort padded soft seat with adjustable leg angle, height and angle adjustable padded backrest, footrest, all-round lifeline, loose mooring and towing line, deck net, rear waterproof storage space with neopren and PE cover
WITH RUDDER [code: 2300522220]	ergonomic comfort padded soft seat with adjustable leg angle, height and angle adjustable padded backrest, adjustable steering footrest, rudder, footrest, all-round lifeline, loose mooring and towing line, deck net, rear waterproof storage space with neopren and PE cover

COLORS





KAYAK PIONEER

MIKE “NECKY” NECKAR

Delsyk kayaks are designed by Mike “Necky” Neckar, a designer and manufacturer of **Delsyk Design kayaks**. Mike is considered one of the most brilliant designers, who has poured over 30 years of experience into perfect results. Thanks to his skills, kayaks of the highest quality and excellent lines are created.

The salt spray kissed Mike “Necky” Neckar’s face as he wrestled another prototype kayak onto the roof of his battered pickup truck. The year was 1970s British Columbia CANADA, a time when fiberglass reigned supreme in the world of kayaking. Neckar, a restless spirit with a knack for tinkering, believed there had to be a better way. He dreamt of kayaks that were tough, affordable, and accessible to everyone, not just elite paddlers.

He began experimenting with polyethylene, a relatively new material at the time. He pushed the boundaries of what was possible, defying conventional wisdom and pushing the limits of kayak design.

His creations were unlike anything seen before. They were robust, yet surprisingly

light. They tracked effortlessly through the water, responsive to the slightest shift in weight. And perhaps most importantly, they were affordable, bringing the joy of kayaking to a wider audience.

Neckar wasn’t just a designer; he was a true craftsman, a visionary who saw the potential in this revolutionary material. He poured his heart and soul into every kayak, meticulously considering every detail, from the ergonomics of the seat to the subtle curves of the hull.

His innovations weren’t just about performance; they were about accessibility. He wanted to create kayaks that would inspire a love of paddling in everyone, from seasoned adventurers to curious beginners. And he succeeded.

Decades later, the legacy of Mike “Necky” Neckar lives on in every kayak that bears Delsyk name. His innovative designs continue to inspire a new generation of paddlers, reminding us that with passion, ingenuity, and a touch of rebellious spirit, we can all make a lasting impact on the world.

ORMEN LV

Ormen LV is a stable recreational kayak for beginner to intermediate paddlers to build confidence and develop skills. This low volume kayak has a comfortable and generous sized cockpit making it easier to enter and exit the boat. Short length keeps it maneuverable and also very easy to handle outside the water. Best suited for day-touring and kayaking on inland waters.

Ormen series kayaks are equipped with SmartTrack rudder and retractable skeg. Ormen LV, MV and HV are available in single-layer HDPE.

ORMEN HV

Ormen HV is a great recreational touring kayak with an excellent glide and maneuverability. This kayak is an efficient kayak that maintains speed very well and has good acceleration. The hard chine hull provides greater initial stability and good maneuverability. Ormen high volume is designed to fit the larger paddler.

Ormen series kayaks are equipped with SmartTrack rudder and retractable skeg. Ormen LV, MV and HV are available in single-layer HDPE.

ORMEN MV

Ormen MV is a recreational kayak with superb maneuverability and good tracking. The hull type provides greater initial stability and a fair amount of speed. It is well suited for touring and coastal adventures with enough storage capacity for overnight and weekend trips.

Ormen series kayaks are equipped with SmartTrack rudder and retractable skeg. Ormen LV, MV and HV are available in single-layer HDPE.

CONSTRUCTION	1 - layer HDPE
STORAGE	front: round hatch 24 cm rear: oval hatch 44 x 26 cm
ORMEN LV	2 handles, comfortable seat, deck bungees, front round hatch with dry storage space, rear oval hatch with dry storage space, thigh pads, steering footrest, smart track rudder system, retractable skeg, skeg control
ORMEN MV / HV	2 handles, comfortable seat, deck bungees, front round hatch with dry storage space, rear oval hatch with dry storage space, thigh pads, steering footrest, smart track rudder system, retractable skeg, skeg control, net

COLORS



mango red

blue



ORMEN LV

ORMEN MV

ORMEN HV

LENGHT	425 cm	445 cm	479 cm
WIDTH	65 cm	62 cm	59 cm
WEIGHT	25 kg	26 kg	26 kg
CAPACITY, MAX.	135 kg	150 kg	150 kg
COCKPIT	115 x 50 cm	95 x 47 cm	95 x 49 cm
CODE	2300091130	2300091140	2300091150

LS SOLO

The Lifestyle Solo is suitable for smaller size paddlers, who appreciate stability and safety. Lifestyle Solo is extremely stable. It has exceptional handling, but also a surprising amount of speed to keep things fun. Lifestyle Solo is equipped with two round hatches for easier packing and storing all your gear.

LENGTH / WIDTH	382 cm / 54 cm
WEIGHT	21 kg
CAPACITY, MAX.	90 kg
COCKPIT	72 x 42 cm
CONSTRUCTION	3 - layer HDPE
STORAGE	front: round hatch 24 cm rear: round hatch 24 cm
FEATURES	2 handles, comfortable padded seat, deck bungees, two round hatch with dry storage space, thigh pads, rudder, steering footrest
CODE	2300091200

COLORS



PLAYSPIRIT

The PlaySpirit is designed to keep things fun! With rocker hull-shape, it is a playful kayak. PlaySpirit handles the waves easily. With a hard chine and a V-shaped bottom with fine endings at the bow and stern, this kayak is made to maneuver. A set of three storage hatches can fit the gear easily in addition to numerous cords on the deck. This kayak has a great stability and fits easily with most of the body types.

LENGHT / WIDTH	467 cm / 59 cm
WEIGHT	25 kg
CAPACITY, MAX.	120 kg
COCKPIT	90 x 49 cm
CONSTRUCTION	3 - layer HDPE
STORAGE	front: round hatch 24 cm day-hatch: 15 cm rear: oval hatch 44 x 26 cm
FEATURES	2 handles, comfortable padded seat, deck bungees, life line, track rudder system, steering footrest, front round hatch with storage space, rear oval hatch with storage space, day hatch, tight pads
CODE	2300091210

COLORS



YOUR JOURNEY

YOUR KAYAK

YOUR FREEDOM





REVAL LV / MV

Reval kayaks are British style kayaks with slightly more volume. Reval series kayaks have superb stability and performance in all sea conditions. These kayaks are responsive and really easy to turn. The hull is designed with rocker and upswept bow and stern. The initial stability of Reval kayaks is a little higher, providing a secure feeling. Reval is a superb sea touring kayak suitable for paddlers who are looking for a nice British style kayak that can handle more challenging sea conditions.

Reval LV (PE) is the lowest volume kayak in the series. LV is perfect for a medium sized paddler who wants to enjoy a roomier cockpit area. The LV cockpit with thigh braces provides an easier entry and good support. The kayak deck is equipped with 1 oval hatch, 1 round hatch, and a day-hatch for easier access into compartments.

Reval MV PE has slightly more volume than the LV version, which makes it well suited for weekend-trips and shorter expeditions. Reval MV is a tough kayak ideal for all adrenaline seekers. The MV is responsive and wonderfully stable even in breaking waves and strong winds. The kayak deck is equipped with 1 oval hatch, 1 round hatch, a mini box in the front and a day-hatch for easier access into compartments.

CONSTRUCTION	3 - layer HDPE
STORAGE	front: round hatch 24 cm mini-box: 15 cm day-hatch: 15 cm rear: oval hatch 44 x 26 cm
FEATURES	2 handles, comfortable seat, deck bungees, life line, track rudder system, steering footrest, retractable skeg, skeg control, front round hatch with storage space, rear oval hatch with storage space, mini box, day hatch, tight pads

COLORS



yellow

red

blue

SEA KAYAK



REVAL LV

REVAL MV

LENGTH	490 cm	515 cm
WIDTH	54 cm	56 cm
WEIGHT	26 kg	130 kg
CAPACITY, MAX.	120 kg	28 kg
COCKPIT	88 x 51 cm	86 x 48 cm
CODE	2300091220	2300091230

PLAY LV / MV

Arrow Play series kayaks are all performance sea kayaks, developed specially for maneuvering and playing on the sea. These kayaks are also excellent for day trips and longer overnight getaways. The hull has significant rocker and volume in the bow to avoid diving when riding down the wave. The mid-section has a slightly rounded profile, making it very smooth from edge to edge. This combined with the hard chines make the Play a joy to paddle whether you enjoy the rough stuff or just want a sea kayak that responds instantly to your moves. The Play series has proven to be our most popular sea kayaks in Scandinavia. Play series deck is smooth with soft lines; especially the front deck, which will catch less wind.

The **Play LV** PE is the smallest kayak in the Play series and is suitable for smaller paddlers. Play LV still offers plenty of storage for longer trips.

Play MV PE has a slightly raised deck compared to the Play LV for more comfort and room in the cockpit. The key selling point for the Play MV is versatility – it fits a wide range of paddlers in almost all skill levels.

CONSTRUCTION 3 - layer HDPE

COLORS



PLAY LV

PLAY MV

LENGTH	517 cm	517 cm
WIDTH	54 cm	54 cm
WEIGHT	28 kg	28 kg
CAPACITY, MAX.	140 kg	150 kg
COCKPIT	81 x 42 cm	81 x 42 cm
FEATURES	2 handles, comfortable seat, deck bungees, life line, footrest, retractable skeg, skeg control, front round hatch with storage space, rear oval hatch with storage space, mini box, day hatch, tight pads	
STORAGE	front: round hatch 24 cm; mini-box: 15 cm; day-hatch: 15 cm; rear: oval hatch 44 x 26 cm	
CODE	2300091330	2300091270



NUKA MV

The Nuka MV PE is a straight line speed optimized sea kayak for smaller paddlers. It has rounded hull for less resistance and less wetted surface, making it glide very well through the water. The Arrow Nuka MV PE is a touring kayak and has much practical deck line layout. The rear hatch is oval making it easy to load the kayak on overnight trips. The Nuka MV PE has less rocker and more raking bow and stern which increases the waterline when loaded.

The Nuka MV PE is equipped with a retractable skeg and can be easily fitted with a rudder for those who prefer to focus forward momentum rather than the correction strokes and edging.

LENGTH / WIDTH	505 cm / 52 cm
WEIGHT	27 kg
CAPACITY, MAX.	145 kg
COCKPIT	80 x 41 cm
CONSTRUCTION	3 - layer HDPE
STORAGE	front: round hatch 24 cm day-hatch: 15 cm mini-box: 15 cm rear: oval hatch 44 x 26 cm
FEATURES	2 handles, comfortable seat, deck bungees, life line, footrest, retractable skeg, skeg control, front round hatch with storage space, rear oval hatch with storage space, mini box, day hatch, tight pads
CODE	2300091300

COLORS





SAGA

Saga kayaks are fast, efficient and a joy to paddle. Saga features a shallow V-shaped hull which ensures fast acceleration, speed, and a nice balance between maneuverability and tracking. It suits for a wide range of kayak ers with different skill levels. Saga can handle a variety of paddling conditions on the ocean and is equipped with three hatches and spacious storage compartments for all the equipment you may need. Saga is an excellent choice for exercise and longer expeditions.

LENGHT / WIDTH	505 cm / 54 cm
WEIGHT	28 kg
CAPACITY, MAX.	130 kg
COCKPIT	89 x 49 cm
CONSTRUCTION	3 – layer HDPE
STORAGE	front: round hatch 24 cm day-hatch: 15 cm mini-box: 15 cm rear: oval hatch 44 x 26 cm
FEATURES	2 handles, comfortable seat, deck bungees, life line, track rudder system, steering footrest, retractable skeg, skeg control, front round hatch with storage space, rear oval hatch with storage space, mini box, tight pads
CODE	2300091370

COLORS

red

blue



BARA

Bara is a Polyethylene sea kayak, range for a mid-sized kayak. Built to handle rough water and longer distances, the Bara offers excellent carrying capacity, easy maneuverability, and a solid platform. This kayak features a roomy cockpit designed for comfort and ease of use.

Ideal for a wide range of paddlers, the Bara is perfect for those looking for a high-performance touring and expedition kayak. With multiple storage compartments, it allows you to load all your gear, while the day hatch ensures that your essentials stay close at hand while on the water.

LENGTH / WIDTH	526 cm / 56 cm
WEIGHT	27 - 29 kg
CAPACITY, MAX.	156 kg
COCKPIT	84 x 44 cm
CONSTRUCTION	3 - layer HDPE
FEATURES	2 handles, comfortable seat, deck bungees, life line, track rudder system, steering footrest, retractable skeg, skeg control, front round hatch with storage space, rear oval hatch with storage space, mini box, day hatch, tight pads
CODE	2300091290

COLORS



SEA KAYAK





RECREATIONAL

RotoAttivo recreational kayak are user-friendly, stable, and versatile watercraft designed for casual paddling on calm waters such as lakes, slow-moving rivers, and coastal areas. These kayaks feature a wide hull for enhanced stability, making them ideal for beginners or those seeking a relaxed experience. They prioritize ease of use, comfort, and affordability over speed or advanced performance, making them perfect for leisure activities, wildlife observation, or short paddling trips.

TUKTU 315

Delsyk Tuktu is a highly stable touring kayak perfect for beginners, offering easy and safe navigation on the water. It's ideal for weekend trips or even just a few hours after work. The Tuktu boasts an exceptionally well-designed cockpit and comfortable seating. The backrest can be adjusted both in height and angle, while the thigh rests can also be adjusted (seat angle). The large cockpit opening is suitable for larger individuals (up to 135 kg) and is especially comfortable for anglers or photographers. The angled sides allow for efficient paddling and maneuvering on the water. It holds its course very well, even on lakes in windy conditions or against waves. Weighing only an impressive 19 kg, the Tuktu is easy to transport and carry. Thanks to the waterproof rear compartment, you can pack luggage in the Tuktu. Enjoy both fun and comfort with this kayak.

LENGTH / WIDTH 315 cm / 68 cm

WEIGHT 19 kg

CAPACITY, MAX. 145 kg

COCKPIT 112 x 56 cm

STORAGE SPACE STERN 75 L

CODE 2300522150

BASIC ergonomic comfort padded soft seat with adjustable leg angle, height and angle adjustable padded backrest, adjustable footrest, all-round lifeline, loose mooring and towing line, deck net, waterproof storage space with neopren cover, PE cover

COLORS



WAIKIKI

The Waikiki kayak is the perfect choice for recreational touring, designed to provide maximum stability and ample storage space for your camping gear. Its uniquely shaped hull ensures smooth gliding through the water while offering outstanding balance.

The Waikiki kayak offers excellent stability and storage space, making it perfect for recreational touring. With two versions to choose from, Waikiki Base for a simpler setup, and Waikiki Expedition for added features like an adjustable seat and skeg, this kayak is designed for comfort and reliability on every water adventure. Ideal for both beginners and seasoned paddlers.



LENGHT / WIDTH	315 cm / 72 cm
WEIGHT	23 kg
CAPACITY, MAX.	130 kg
COCKPIT	90 x 50 cm
CODE	2300091250
BASIC	PE seat with backrest, footrest, deck bungees
EXPEDITION	PE seats with padding with backrest, skeg, round hatch, bulkhead, deck bungees, paddle holder, footrest

COLORS



FIT 96 / 111

The **Fit 96** is the shortest recreational kayak (2,9 m) in Fit range. This kayak offers truly enjoyable paddling, especially on narrower and smaller rivers & lakes. It is well suited for beginners to intermediate paddlers and due to its roomy cockpit it suits perfectly to different body types.

The **Fit 111** is a very stable recreational kayak for day-trips. This kayak provides increased speed compared to Fit 96. The Fit 111 glides well and tracks straight. It has a comfortable and generous sized cockpit making it easier to enter the boat.

CONSTRUCTION 1 - layer HDPE

COLORS



FIT 96

FIT 111

LENGTH	290 cm	337 cm
WIDTH	76 cm	72 cm
WEIGHT	22 kg	23 kg
CAPACITY, MAX.	130 kg	130 kg
COCKPIT	115 x 50 cm	115 x 50 cm
STORAGE	rear: round hatch 24 cm	mini-box: 15 cm rear: oval hatch 44 x 26 cm
FEATURES	2 handles, comfortable seat, deck bungees, rear round hatch with dry storage space, footrest	2 handles, comfortable padded seat, deck bungees, front round hatch with dry storage space, rear oval hatch with dry storage space, thigh pads, footrest
CODE	2300091160	2300091170

JAMAICA

2-SEATED

The Jamaica Base is a highly stable tandem kayak, perfect for families of up to three. With its semi-open hull, easy entry and exit, and splash protection, it's ideal for calm waters like lakes, rivers, and beach days. Enjoy a comfortable paddling experience with space for one child (or pet) between two adults.

The kayak's unique semi-open hull allows for easy entry and exit while offering better splash protection than a fully open sit-on-top kayak. This design eliminates the need for a splash apron, making it more convenient and comfortable.



LENGTH / WIDTH	315 cm / 72 cm
WEIGHT	23 kg
CAPACITY, MAX.	130 kg
COCKPIT	90 x 50 cm
CODE	2300091180
OPTIONAL	soft backrest and padded seat
STORAGE	rear: round hatch 24 cm

COLORS



SIT ON TOP

RotoAttivo sit-on-top kayaks are an open-deck kayaks designed for ease of use, comfort, and versatility, making the ideal for beginners and recreational paddlers. Unlike traditional kayaks, it has no enclosed cockpit, allowing paddlers to sit on top of the hull. This design provides excellent stability, easy entry and exit, and reduces the risk of feeling confined. They are suitable for warm climates, fishing, or activities where getting wet is part of the fun. They are perfect for calm waters, coastal areas, and short paddling adventures.





rot ATM

URSIS

VIS 260 / 290

Sit on top kayak with great sailing compatibility and stability. Vis 260 and 290 twin kayaks with the same shapes but different sizes. The vis 260 is a smaller model oriented more towards smaller paddlers or women. The Vis 290 is a bigger kayak, which also has a dry compartment in the middle.



VIS 260

VIS 290

LENGHT	260 cm	290 cm
WIDTH	70 cm	80 cm
HEIGHT	24 cm	28 cm
WEIGHT	17 kg	20 kg
CAPACITY, MAX.	100 kg	130 kg
BASIC	handles, drain plug, waterbottle place, selfdraining	handles, drain plug, waterbottle place, selfdraining
WEEKEND	handles, drain plug, waterbottle place, rubbernet for luggage, selfdraining, deckffiting with rubberstrap	handles, drain plug, waterbottle place, round hatch, rubbernet for luggage, selfdraining, deckffiting with rubberstrap
CODE	BASIC [code: 2300520800] WEEKEND [code:2300520830]	BASIC [code:2300520810] WEEKEND [code:2300520820]

COLORS



AQUA MOON

The Aqua Moon is a comfortable and stable sit-on-top kayak. It is a versatile kayak that is ideal for paddling or fishing on the river or around the coastline. The kayak is equipped with a paddle holder on the side, rear storage area with netting and one front hatch for safe and dry storage. Four scupper holes with bungs won't let the water in and they allow draining it out from the kayak. To keep you cooled with your favorite beverages and keep the essential gear close to you the Aqua Moon has a console in the front with netting and a bottle holder.



LENGHT / WIDTH	300 cm / 75 cm
WEIGHT	24 kg
CAPACITY, MAX.	150 kg
FEATURES	paddle holder, rear storage ares with netting, round front hatch with dry storage, 2 handles, scupper holes with bungs, console with netting and water bottle holder, safety lines, integrated footrest
CODE	2300091110

COLORS



KAILUA

Sea star is a sit on top kayak, which makes it perfect for summer holiday sea trips, or even fishing trips. Yes, the Sea star is also available as a fishing variant. Sea star seats one adult comfortably, it has a dry storage compartment in the front and middle. It also has adjustable foot rests for maximum control.



LENGTH / WIDTH 370 cm / 86 cm

WEIGHT 29 kg

CAPACITY, MAX. 210 kg

FEATURES integrated footrest, integrated handles, integrated side handles, deck bungees, soft seats

CODE 2300091120

COLORS



orange



blue green

DALMATIC 270

Dalmatic is a must-have leisure kayak for everyone. Perfect for advanced paddlers, amateurs and everyone who just wants a sneak peak in the kayak world. To deliver on every field, Dalmatic comes in three different trim levels; basic, weekend and fishing.



LENGHT / WIDTH	270 cm / 82 cm
HEIGHT	41 cm
WEIGHT	21 - 23 kg
CAPACITY, MAX.	90 kg
BASIC {code:2300069060}	handles, selfdraining
WEEKEND {code: 2300369060}	handles, drain plug, paddle holder, deckfitting with rubberstrap, round hatch, selfdraining
FISHING {code: 2300669060 }	handles, drain plug, paddle holder, deckfitting with rubberstrap, rod holders, round hatch, selfdraining

COLORS



LOL 300

LOL 300 kayaks are the result of a project finalized to create an icon sit on top for simplicity and ease of use. Extremely stable and fast, easy to handle, self draining and unsinkable, it also provides kayak beginners with hours of pure entertainment.



LENGHT / WIDTH 300 cm / 80 cm

HEIGHT 35 cm

WEIGHT 23 kg

CAPACITY, MAX. 90 kg

BASIC
[code: 2300095500] drain plug, waterbottle holder, selfdraining, rear seat for passenger, front seat for child, wheel, stackable, deckfitting

WEEKEND
[code: 2300395500] drain plug, waterbottle holder, paddle holder, round hatch, selfdraining, rear seat for passenger, cushion soft seats, front seat for child, wheel, stackable, deckfitting

FISHING
[code: 2300695500] drain plug, waterbottle holder, paddle holder, round hatch, rod holders, selfdraining, rear seat for passenger, cushion soft seats, tallon connectors, front seat for child, wheel, stackable, deckfitting

COLORS



SEA STAR 445

Sea star is a sit on top kayak, which makes it perfect for summer holiday sea trips, or even fishing trips. Yes, the Sea star is also available as a fishing variant. Sea star seats one adult comfortably, it has a dry storage compartment in the front and middle. It also has adjustable foot rests for maximum control.



LENGTH / WIDTH	445 cm / 78 cm
HEIGHT	32 cm
WEIGHT	29 kg
CAPACITY, MAX.	90 kg
BASIC [code: 2300073800]	2 handles, deck fittings
WEEKEND [code: 2300373800]	2 handles, deck fittings, bungees, adjustable footrest, front round PE hatch, middle square PE hatch
FISHING [code: 2300273800]	2 handles, deck fittings, bungees, adjustable footrest, front round PE hatch, middle square PE hatch, rod holder

COLORS



LOL 400

LOL 400 A family version of the LOL1 is able to carry up to four people. Similar in design it's enriched by sliding front backrest which turns the LOL2 into a great single kayak. Ergonomic seats and lowered foot area makes the cockpit area very comfortable even for strong paddlers. The addition of two compartments on the sides and one in the centre of the kayak allow to bring with you everything is necessary for an enjoyable freetime.

LENGHT / WIDTH	400 cm / 80 cm
HEIGHT	38 cm
WEIGHT	33 kg
CAPACITY, MAX.	180 kg
BASIC [code: 2300095510]	drain plug, waterbottle holder, adjustable backrest, selfdraining, rear seat for passenger, front seat for child, wheel, deckfitting, 3rd central seat
WEEKEND [code: 2300395510]	drain plug, waterbottle holder, adjustable backrest, paddle holder, round hatch, selfdraining, rear seat for passenger, cushion soft seats, front seat for child, wheel, deckfitting, 3rd central seat
FISHING [code: 2300695510]	drain plug, waterbottle holder, adjustable backrest, paddle holder, round hatch, rod holders, selfdraining, rear seat for passenger, cushion soft seats, tallon connectors, front seat for child, wheel, deckfitting, 3rd central seat

COLORS



VIS 420 tandem

Vis 420-the big brother of Vis range. The perfect leisure tandem kayak. It has all the great sailing characteristics of the smaller Vis kayaks but it can seat two adults comfortably. The 420 also has storage areas in the back and dry compartments in front of each paddler.



LENGHT / WIDTH 420 cm / 85 cm

HEIGHT 30 cm

WEIGHT 34 kg

CAPACITY, MAX. 200 kg

BASIC
[code: 2300520840] handles, drain plug, waterbottle place, selfdraining

WEEKEND
[code:2300520850] handles, drain plug, waterbottle place, round hatch, rubbernet for luggage, selfdraining, deckffiting with rubberstrap

COLORS



CROSS OVER

Cross over kayaks combine the stability and comfort of recreational models with features suited for moving water, such as a rockered hull for maneuverability and often a retractable skeg or rudder for improved tracking.



VERVE 310

Verve is an excellent multipurpose kayak, a perfect companion for those who love adventures. Super easy to paddle and very stable or playful, depending if you keep the skeg closed or opened.



LENGTH / WIDTH	310 cm / 66 cm
HEIGHT	39 cm
WEIGHT	23 kg
CAPACITY, MAX.	100 kg
BASIC [code: 2300095520]	2 handles, deck fittings
WEEKEND [code: 2300395520]	2 handles, deck fittings, bungees, adjustable footrest, front round PE hatch, middle square PE hatch
FISHING [code: 2300695520]	2 handles, deck fittings, bungees, adjustable footrest, front round PE hatch, middle square PE hatch, rod holder

COLORS





WILD WATER

A wild water kayak is a specialized performance kayak designed for navigating fast-moving, turbulent whitewater rivers and rapids. It features a narrow, streamlined hull for speed and agility, allowing paddlers to maneuver quickly in challenging water conditions. Typically shorter than other kayak types, wild water kayakers have a planing or displacement hull, providing excellent control and responsiveness.



ORGASMO 255

ICF certified kayak, designed after years of testing and research. A perfect mix of elements, the kayak Orgasmo is the benchmark for wildwater competitions for hundreds of rivers around the world. Sitting in the Orgasmo, you will never believe the kayak is 255 cm long. Everything is designed for maximum connection of a paddler with a kayak. The Ergonomic seat, large and deep thigh brace and adjustable backrest will instantly put you in the shoes of whitewater paddling.



LENGTH / WIDTH	255 cm / 66 cm
HEIGHT	40 cm
WEIGHT	22 kg
CAPACITY, MAX.	95 kg
COCKPIT	87 x 47 cm
BASIC [code: 2300095530]	drain plug, adjustable seat, metal handles
ADVANCED [code: 2300195530]	drain plug, adjustable seat, adjustable backrest, adjustable footrest, metal handles, side pillow, front and rear PE pillar (inside), padded seat

COLORS



TODO 260

Play Kayak perfect for ripping it up at your local play spot, learning new tricks or even surfing the waves. This freestyle kayak comes as a complete package for ultimate enjoyment .



LENGHT / WIDTH 260 cm / 70 cm

HEIGHT 45 cm

WEIGHT 19 kg

CAPACITY, MAX. 95 kg

COCKPIT 75 x 42 cm

ADVANCED
[code: 2300395550] handles, drain plug, adjustable seat, adjustable backrest, adjustable footrest, front PE pillar (inside), side pillow, front and rear PE pillar (inside), padded seat, cushioned seats, footrest

COLORS



eTUKTU

eMOGI kayak includes

- paddle with remote control buttons,
- battery as per customers choice,
- safety magnetic kill switch,
- magnetic key for stern hatch,
- foldable propeller a spare proppeler blades.

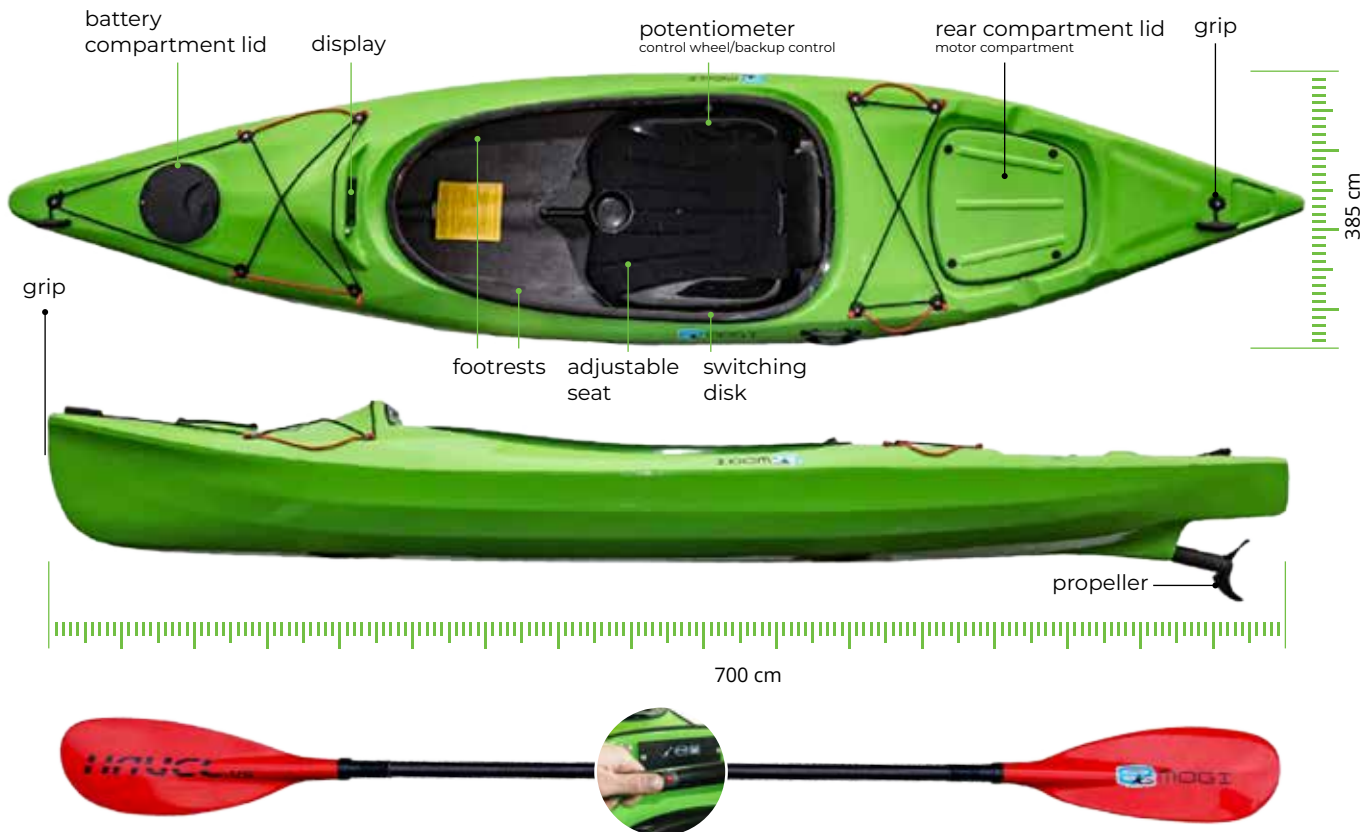

LENGHT / WIDTH	700 cm / 38,5 cm
WEIGHT	25 kg
CAPACITY, MAX.	135 kg
COCKPIT	120 x 60 cm
MAX. SPEED	20 km/h
BATTERY	24 V 40Ah - 83Ah / 932Wh - 1,842Wh
ELECTRIC MOTOR	1kW

COLORS



PONTOONS

Pontoons are floating platforms, created for different kinds of purposes. ROTO Pontoons are designed for great buoyancy, stability and safety. Components are ready-made – plug & play system – installation and disassembly is quick and easy. All these things make ROTO Pontoon Systems a cost-effective product.

Pontoon Systems can be used for sporting purposes, to moor the boats, as a swimming platform, mobile platform for houses, as a floating bridge to cross the water, as a platform for beach bar and much more. They are designed to be stable and safe on water.

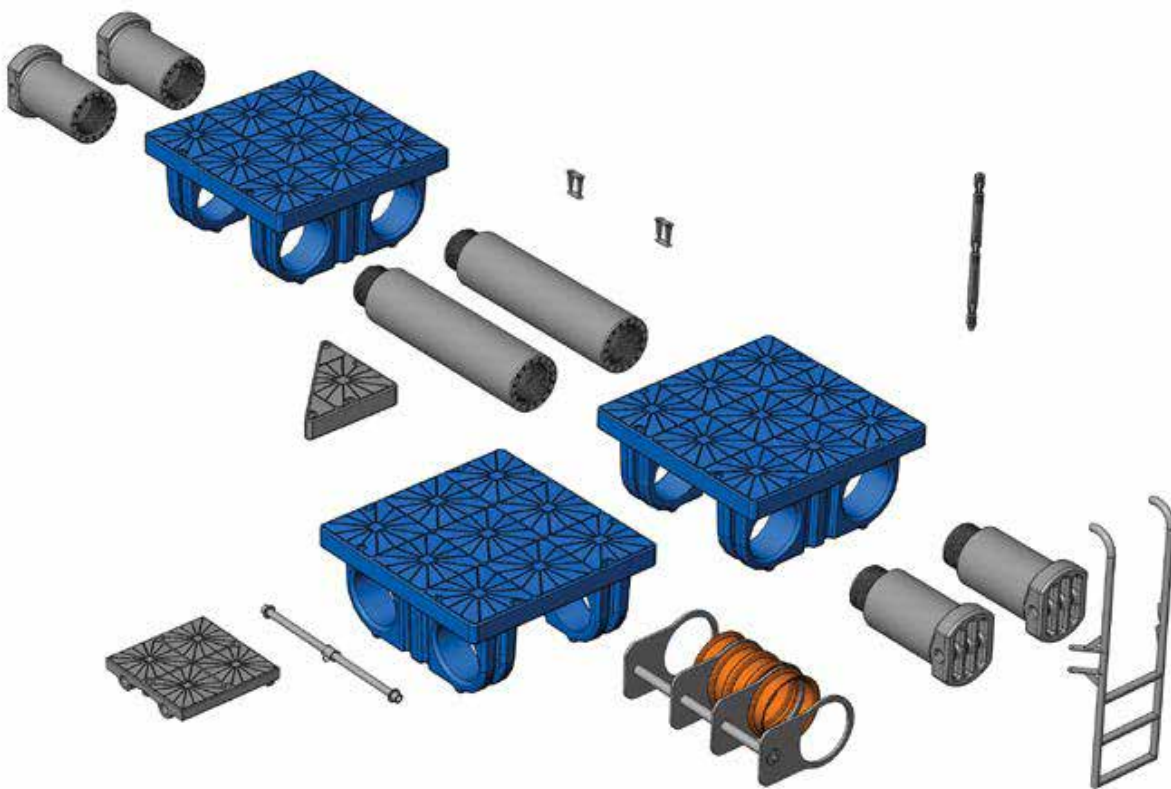

DIMENSIONS	1500 x 1500 mm
WEIGHT	70 kg + tubes
LOADING CAPACITY	350 kg/m ²
WAVE RESISTANT	up to 2 m high waves on open water
MATERIAL	Polyethylene, UV-stable, mid density

COLORS



PONTOONS

HYDRA 450/530

Stable. Reliable. Easy to handle.

The “Hydra450” motorboat is setting new standards in the rotational molding boat industry.

Its ergonomic design ensures exceptional versatility, making it ideal for families, fishermen, professionals like firefighters and rescue divers and sailing school instructors seeking a reliable and safe training vessel.

The Hydra450 is available in several versions with a side console, central console or without a console.

It is a one-piece rotationally molded boat, manufactured in 3-layer sandwich

technology. This unique production concept ensures the hull’s exceptional rigidity, high impact resistance, and lightweight properties.”

Compared to the boats made in GRP technology, polyethylene boats can use engines with less power to achieve same speed and performance. The 3-layer polyethylene material provides also amazing buoyancy, UV stability, and has low maintenance costs.

“Hydra450” motorboats are 100% recyclable and also have an option to be made from recycled materials.



	HYDRA 450	HYDRA 530
LENGHT	450 cm	530 cm
WIDTH	180 cm	220 cm
HEIGHT	80 cm	119 cm
WEIGHT BASIC	281 kg without console	480 kg
CAPACITY	Certification class C=5 Certification class D=7	Certification class C=8 people Certification class D=10 people
MOTOR	up to 20 HP without steering console 6-60 HP with steering console	gasoline up to 100 HP

COLORS



KORKYRA 650

Designed for confidence.

Engineered for superior stability.

The design of the “Korkyra650” catamaran is elegant, modern and expresses confidence on the water. This vessel will excite both, experienced sailors and adventurous beginners.

“Korkyra” catamarans are made from “multi-hull rotationally molded floaters” connected with the rigid aluminum sandwich platform. The combined structure enables cost

efficient container shipping also available in disassembled form.

The main floaters are manufactured in one shot molding using unique 3-layer technology. The high-performance double hull is characterized by exceptional rigidity, high impact resistance and low weight.

All components of the catamaran are UV-resistant and fully recyclable at the end of their lifecycle, ensuring sustainability without compromising performance.



LENGHT	650 cm
WIDTH	240 cm
HEIGHT	239 cm (incl. Hardtop or T top)
WEIGHT	953 kg standard 978 with loading platform
CAPACITY	Certification class C=10 Certification class D=12
MOTOR	electric engine up to 2x 20 kW gasoline engine up to 2x 60 HP

COLORS



BACK TO NATURE



Soča is a 137-kilometre long river that flows through western Slovenia and east Italy. An Alpine river in character, its source lies in the Trenta Valley in the Julian Alps. Soča is one of the most beautiful rivers in Europe, an important natural treasure in the Triglav National Park. It is famous for its deep emerald colour and brisk rapids in the upstream area. The Soča River is a veritable paradise for water sports enthusiasts, particularly fans of kayaking and fishing, as well as photographers and people looking to relax in natural surroundings.

Visit Slovenia and discover Soča.



**PROUD
SPONSOR
OF
OLYMPICS
ATHLETES**



AFTER

ZERO ATTIVO
energia all'acqua

OSAGIAN

DELSYK
DESIGN

Zegul



COMES

rot  **ATTIVO**



ROTO
Puconci 12
9201 Puconci
Slovenia
rotoattivo@roto.si
+386 2 52 52 241

WWW.ROTOATTIVO.EU

01/25